



PlayStation

TM

NTSC U/C

PlayStation



LOOM™

BODY BAG NOT INCLUDED



SLUS-00076
MN-PSX-636-0



**WARNING: READ BEFORE USING YOUR PlayStation™
GAME CONSOLE.**

A very small percentage of individuals may experience epileptic seizures when exposed to certain light patterns or flashing lights. Exposure to certain patterns or backgrounds on a television screen or while playing video games, including games played on the PlayStation game console, may induce an epileptic seizure in these individuals. Certain conditions may induce previously undetected epileptic symptoms even in persons who have no history of prior seizures or epilepsy. If you, or anyone in your family, has an epileptic condition, consult your physician prior to playing. If you experience any of the following symptoms while playing a video game – dizziness, altered vision, eye or muscle twitches, loss of awareness, disorientation, any involuntary movement, or convulsions – IMMEDIATELY discontinue use and consult your physician before resuming play.

WARNING TO OWNERS OF PROJECTION TELEVISIONS:

Do not connect your PlayStation game console to a projection TV without first consulting the user manual for your projection TV, unless it is of the LCD type. Otherwise, it may permanently damage your TV screen.

HANDLING YOUR PlayStation™ DISC:

- This compact disc is intended for use only with the PlayStation™ game console.
- Do not bend it, crush it or submerge it in liquids
- Do not leave it in direct sunlight or near a radiator or other source of heat.
- Be sure to take an occasional rest break during extended play.
- Keep this compact disc clean. Always hold the disc by the edges and keep it in its protective case when not in use. Clean the disc with a lint-free, soft, dry cloth, wiping in straight lines from center to outer edge. Never use solvents or abrasive cleaners.

LOADED

Table of Contents

Introduction.....	3
Character Assassinations.....	5
Starting the Game.....	8
Walk-Through.....	14
Customer Service/Warranty.....	15
Credits.....	16

©1995 Gremlin Interactive Limited. MCPS. All rights reserved. Loaded is a trademark of Interplay Productions. All rights reserved. Interplay is the sole publisher and distributor. Licensed from and developed by Gremlin Interactive Ltd. Sony® is a registered trademark of Sony Corporation. PlayStation™ and the PlayStation Logo are trademarks of Sony Computer Entertainment Inc.

Playstation Console setup

Set up your PlayStation game console according to the instructions in its Instruction Manual. Make sure the PlayStation power is off before inserting or removing a compact disc. Insert the LOADED disc and close the CD door. Insert game controllers and turn on the PlayStation game console. Follow on-screen instructions to start a game.

Console

Top View

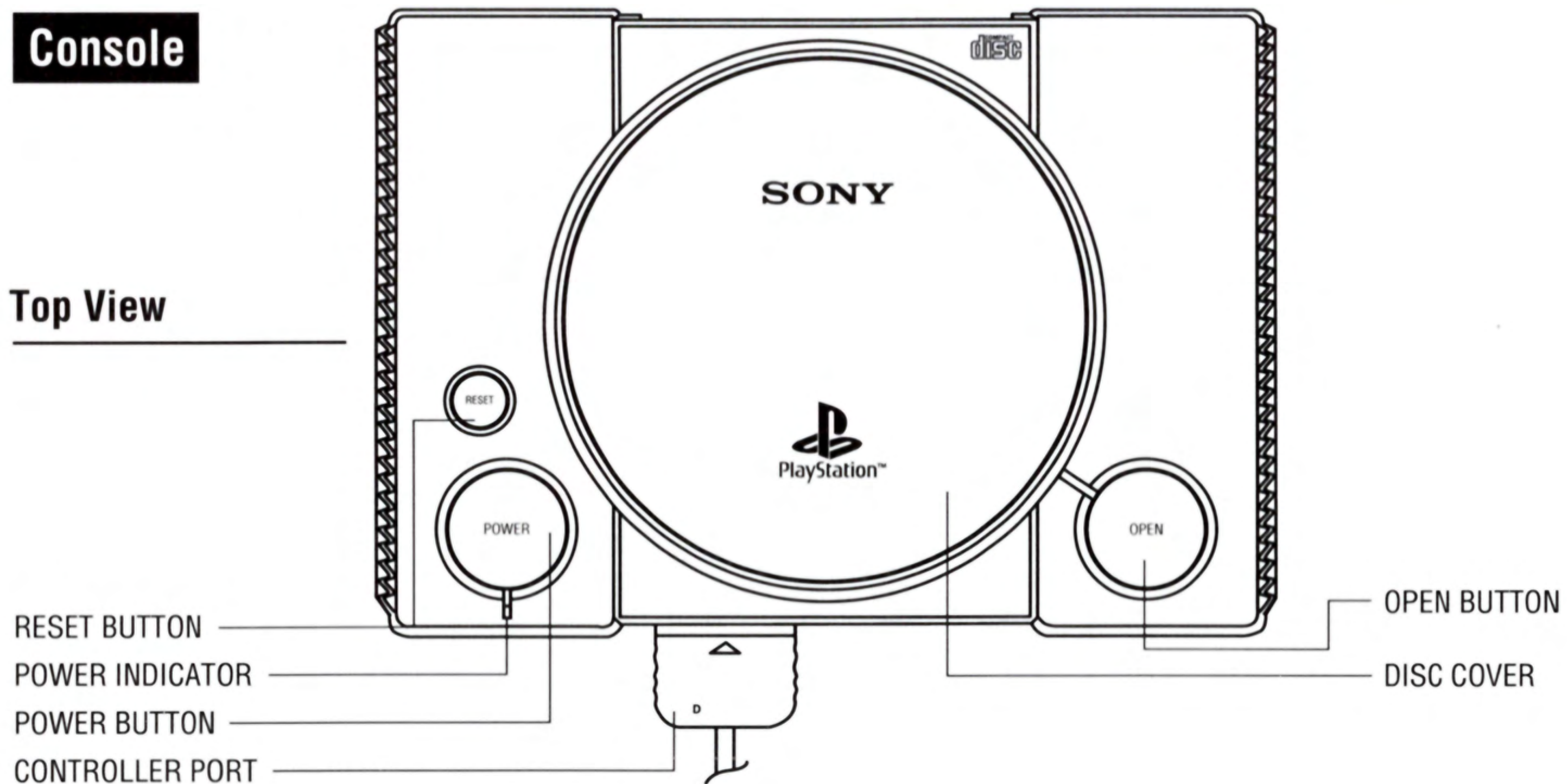

Front View

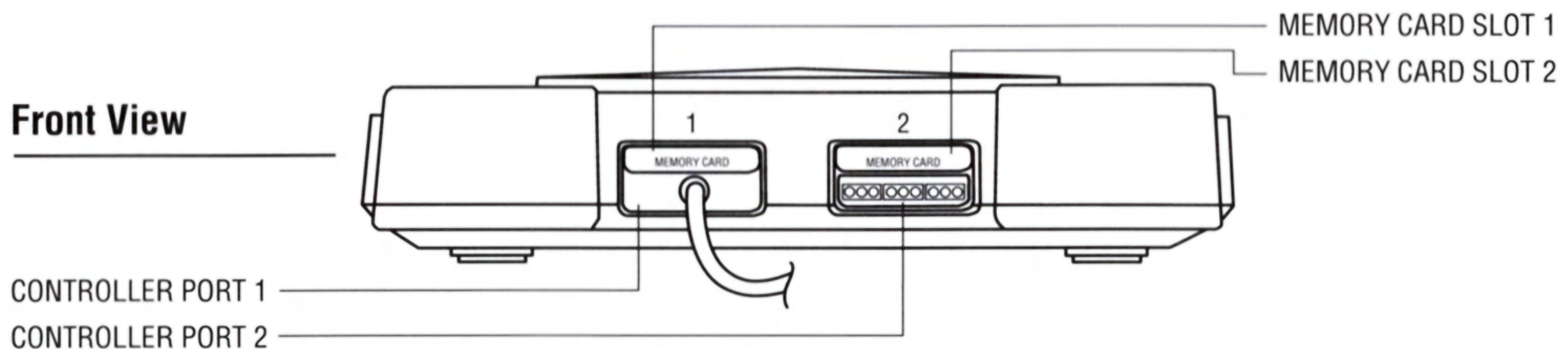

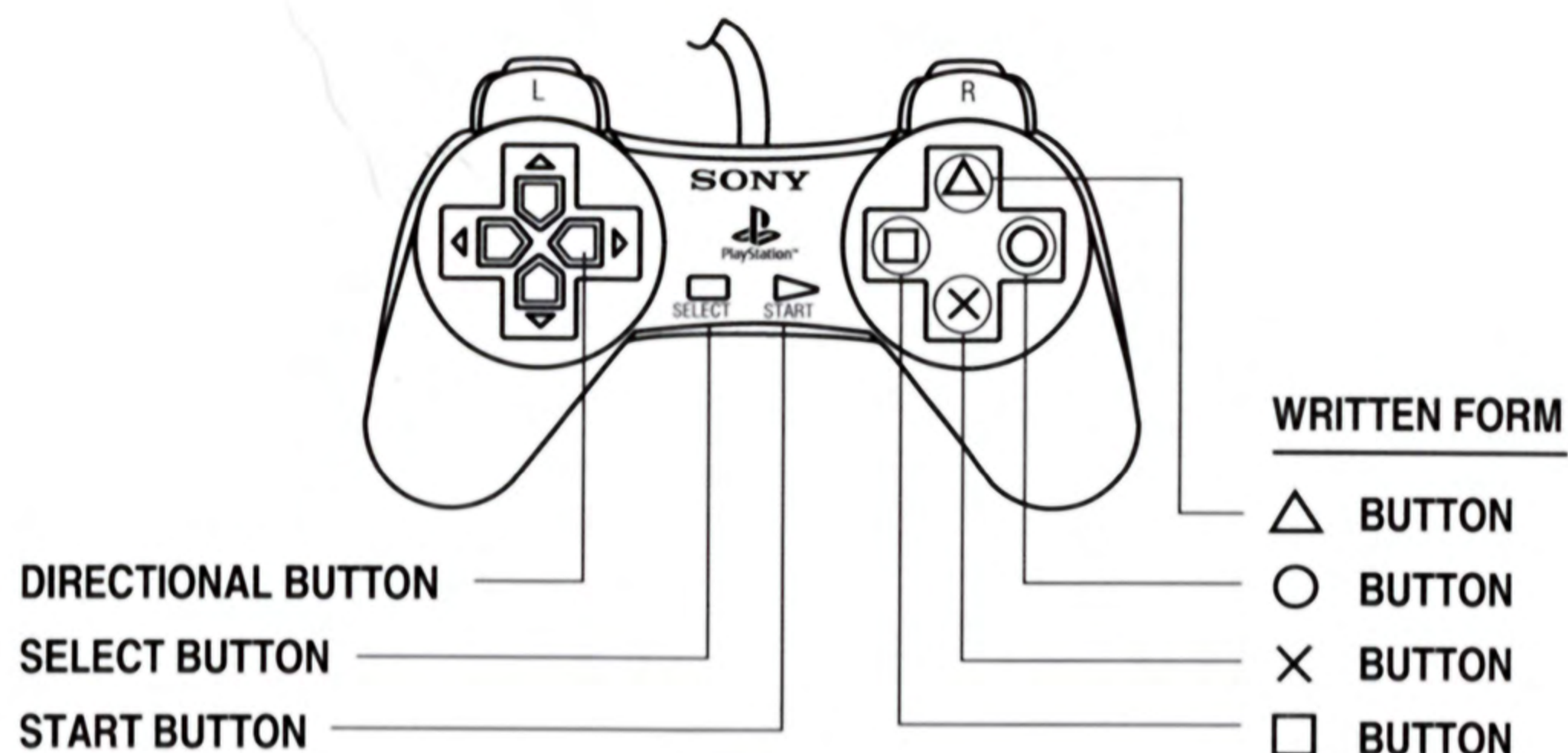

Here's the Story

You are in jail—not just any jail, though; this is the jailer's jail. Situated on the most inescapable and inhospitable barren balls of rock anywhere in the galaxy - the planet RAULF. Long ago, the powers that be built an enormous jail that could contain even the most dangerous and desperate criminals in the galaxy. Individuals who would do the most despicable things at the drop of a hat, people who do not value any form of life which doesn't have their name, vital statistics and finger prints (where applicable).

It was a model prison for several decades, until a certain character called F.U.B (Fat Ugly Boy) became the head warden. Nobody is quite sure how he attained such a high position in such a short time, but the fact that several worthy candidates for the position died suddenly seemed to help.

F.U.B is largely an unknown quantity and very little is known about him. We do know that he likes to bore the waste products out of most life forms with his long-winded, verbose rambling about when he was in the sector marines. All of the stories concern field kitchens though, since he was only in the catering corps, "Did I tell you about the time I dropped an entire jar of Plusgrial fnart powder into the cooking pot?" Since those days though, F.U.B really has gone down in the world, barely stopping for breath it seems.

It all started when he was called to the barren desert front during one of the more obscure skirmishes of the last 40 years. Not able to find some meat for the main dish, and obviously not wanting to let "the boys" down, he cooked and served his legs up in a rich broth. Despite it being the best dish he had ever created F.U.B was still given an

unconditional discharge and asked never to show his face again.

He then set about radically altering his appearance, fitting hydraulic powered legs to his torso and gaining enough weight to put his new legs under stress. He also took to smoking big fat Havanas, wearing furry dice and painting a target on his portly belly. Why? Don't ask me. This type of behavior may seem strange to the average person but there is nothing average about F.U.B - he defies all known logic. F.U.B seems to have some master plan, some illogical reason to be with the scum of the universe.

What most of the prisoners on RAULF don't know though is that F.U.B has put a lot of them there with his own little dirty tricks and double crosses. Deliberately provoking the scum of the galaxy in the hope that when they escape they will come after him with revenge looming large in their minds.

While they've been safely incarcerated, F.U.B has been a busy boy. He has been toying with the very fabric of the universe, creating a machine that changes the way the normal laws of physics behave. With it he is able to manipulate existing terrain, replace it with other terrain even open doorways to other dimensions. With this mighty weapon he hopes to hold planets, solar systems and even entire galaxies for ransom. He aspires to be the most feared and influential individual in the entire history of history. He believes the only way he can possibly be stopped is by a group of dangerous pissed-off law breakers who have a very large axe to grind. This is why he framed so many people in the first place; he sees it as a challenge. If he can defeat a group of the most feared individuals in the galaxy who are armed to the teeth, he figures he can defeat anyone, and who are we to say otherwise?

To this end F.U.B seems to be kind of "encouraging" the prisoners to escape from RAULF, by booby trapping the infra-security structure of the prison, and oddly enough supplying the pass keys for the doors.

His objective seems to be to slowly reel them in, deeper and deeper into his despicable web of megalomania. And ultimately, he believes, to their deaths.



BUTCH

Butch is THE most dangerous cross-dresser currently residing in the galaxy. He does not do it by choice though, every time he escapes he grabs the first item of clothing that comes to hand. By a staggering twist of fate this always seems to be a woman's dress of some description. If he ever crosses your path try to swallow that snigger or lose that laugh, because if he hears you, you will not be capable of doing it for much longer. His favored weapon is a large semi-automatic flame thrower called The Flaming Queen, mainly because when it's lit it sounds like it's barking. A bit like Butch really.

Character Information

SPEED FAST

MAIN WEAPON FLAME THROWER

ARMOR MEDIUM

ULTRA BOMB EXPLOSIVE RING



VOX

This lady is a very cool customer, and should be, because she can kill with a single word (most unprintable here). Some people choose to call her "The Siren" because of her devastatingly sexy countenance. These people are not her favorites. "Do I look like a flashing blue light?" she has been heard to ask many bubbling pools of protoplasm. Her weapon was self-developed with the aid of Gabbist Monks, an order who take the vow never to have a second of peace and quiet and are masters in the art of amplifica-

tion. The device they collaborated on is slung across her back and has a number of "Rapmaster" microphones channeling sound to it via boom mikes on her visor. Vox has an extremely sharp tongue.

Character Information

SPEED FAST

MAIN WEAPON HAIL FLAIL

ARMOR LIGHT

ULTRA BOMB SONIC BLAST



FWaNK

FWaNK is a psychotic. He cares not a jot about his fellow life forms, looking upon them as toys for his amusement or worse, expendable cardboard targets at a fairground attraction. FWaNK has the mental age of a lobotomized six year old and the body of a steroid eating wildebeest who doesn't shower. In fact, the only thing FWaNK cares about is his teddy Percy and keeping his weapon well oiled. FWaNK's true identity is unknown, as he wears a used bank bag over his head. His identity is even more widely speculated on than the late 80's wrestler "Kendo Nagasaki". FWaNK makes one concession to his fellow

life forms; he ties a mood balloon to his back pack indicating the general ballpark of his demeanor: Green for "Chuckly", yellow for "I need space" and red for "I wouldn't ask if I were you".

Character Information

SPEED SLOW MAIN WEAPON NEUTRON SPHERES
ARMOR GOOD ULTRA BOMB HOMING TEDDIES



CAP 'N' HANDS

This guy has been around for centuries. One of the most feared and despised Cirates in all space. Only his head is an original part of his body and that too is rotten to the core. The rest of his powerful frame is an old cyborg design. He could have had it replaced around 200 years ago when technology took a giant step forward but hey—he likes it. Another reason he keeps this ancient and obsolete skeleton is for its amazing array of original art which decorates the majority of its panels. He has kept the inmates of his high security wing amused and beguiled

for hours on end with stories of how he acquired them, and with his famous "Dancing bare lady" design. Only his best friends and people who are about to expire in a horrible manner generally get to see that though.

Character Information

SPEED MODERATE MAIN WEAPON FLINTLOCKS
ARMOR AVERAGE ULTRA BOMB VORTEX BOMB



MAMMA

Mamma is a pratt. He was abandoned as a babe in the busiest starport in the galaxy. A place where no one has any time for anyone else. He is totally without education, manners and all of those other things which are generally regarded as “civilized”. He blunders through life using his very limited vocabulary to get him through all manners of circumstance. The only word he knows, and the only thing that keeps him going is the word “MAMMA!”. Obviously he missed something as an infant. His lineage is therefore something of an unknown quantity, but one thing is certain—his mother was pals with something large and Simian. Quite a scary and unpredictable geezer to have around, even if you are scary and unpredictable yourself.

Character Information

SPEED SLOW MAIN WEAPON PLASMA GUN
ARMOR GOOD ULTRA BOMB RIPPLE BOMB



BOUNCA

Bounca is a strange guy. Certainly one of the most widely traveled and employed organisms in the history of the galaxy. He has seen amazing sights that even the most intrepid galactic explorers would go green at—hidden planets, lost continents and the like. Bounca has a slight problem though; he is incredibly thick. Not just a bit thick, enormously thick. All of his experiences amount to a big fat zero, because the only thing he finds interesting is “slappin’ some innocent geeza about a bit”. You might as well have sent a baboon around the galaxy and then questioned it about its experiences, as it is probably more perceptive and definitely less likely to kill you for asking.

Character Information

SPEED MODERATE MAIN WEAPON MISSILES
ARMOR MEDIUM ULTRA BOMB FRAG MISSILE

STARTING THE GAME

To play LOADED on your Playstation game console:

1. Set up your Playstation game console in accordance with the instruction manual supplied with the system.
2. Follow your system directions to open the CD drive and place the CD onto the bed of the drive, ensuring the printed side faces upwards.
3. Close the CD drive and press the Power button to load and play the game.

MAIN MENU SCREEN

After the game has loaded and the intro has played, the Main Menu screen appears. From this menu, you select your game mode and set up your options for the game. Use up and down on the D-pad to highlight an option and press the X button to select an option.

PLAYERS

Use left and right on the D-pad to toggle through the available options.

1P GAME

Select for a one player game.

2P GAME

Select for a two player game. Ensure you have two Playstation controllers connected before you select this option.

LOAD GAME

Highlight and select this option using the X button. Select Slot 1 or 2 by highlighting and pressing the X button. Then highlight and select Load. Select the previously saved game you want to load using the D-pad to highlight the save and press the X button to load the save. Select Format to wipe your memory card. Anything saved on the card will be lost, so take care when selecting this option. Select Exit to quit back to the Game Options Screen.

GAME OPTIONS SCREEN

Before you've selected your game player mode, highlight Option from the Main Menu and press the X button. You'll be taken to the Game Options menu. On this menu screen use the D-pad to move up and down through the options and press the X button to select an option.

GAME OPTIONS

This menu screen allows you to set up the Loaded game options to your personal taste.

PLAYERS ARE . . .

Select a level of difficulty by choosing from the following:

PLAYERS ARE FAIRIES - Train spotters and stamp collectors only.

PLAYERS ARE BORING - Members of choirs and people who still go shopping with their mums.

PLAYERS ARE CONFIDENT - When you're not playing games you're a stunt double for Schwarzenegger.

PLAYERS ARE BRUTAL - You're a tough bastard and your friends regularly tell you so.

PLAYERS ARE LOADED - Fear ain't in your vocabulary

LIVES

And you should get one if you have to set this option any higher than 3 lives per game. However, we've given you the option to select between 1 to 5 lives per game.

CONTINUES

Keep getting wiped out? Select continues to give you up to 5 continues after the Game Over screen. This allows you to continue on the current level, but you'll have to still start at the beginning of the level though.

BGM VOLUME

Highlight and press left on the D-pad to decrease volume or right to increase background music.

SFX VOLUME

Highlight and press left on the D-pad to decrease volume or right to increase the sound effects volume.

LANGUAGE

Use this menu option to select the language of your preference. Use left and right on the D-pad to toggle throughout the options available.

CONTROLS

This menu screen allows you to change the control method on the Playstation pads. To change any of the settings, highlight the button option you want to change and then press the button you want to use. The column on the left represents player one's buttons and the column on the right represents player two's buttons.

EXIT

Select exit to exit back to the main menu screen.

SELECT A CHARACTER

Once you've selected your game mode and options, it's time to select an alter-ego. On the Main Menu, highlight the game mode you've selected (e.g. 1P Game or 2P Game, etc.) and press any button. You will now be presented with the character selection screen. Use the D-pad to highlight a character and press any button to select. In a two player game it's first come first served, player one's choice is indicated by a red highlighted box and player two's by a blue box. Once you've selected, there's no turning back, sucker. Select Exit to return to the Main Menu.

LET'S GET LOADED - GAME PLAY

There's one basic rule here—if it moves, kill it and kill it quickly before it kills you. Kill the guards, kill your fellow inmates and make a break for the exit in a bid to find F.U.B.

OBJECTIVES

A brief outline of what you have to achieve will be given before each new level. Read this carefully or you could end up being nothing more than a stain on the floor.



CHARACTER CONTROL

Controlling your character in the game is really easy. Use the D-pad to move your character up, down, left and right. You can move at 45 degrees holding down two of the directions on the D-pad (e.g. Up and Right to move up the screen at 45 degrees up and to the right of the screen).

STATUS AND MAP DISPLAY

This displays vital information on your current status.

1. **HEALTH STATUS AND LIVES:** Once the health status bar is depleted, you're pushing up daisies. The number of lives remaining is displayed at the end of your health bar.
2. **AMMUNITION:** If you let this hit zero you're in trouble, so keep your weapon well stocked.
3. **ULTRA BOMBS:** Each lightning flash represents one ultra bomb.
4. **KEYS COLLECTED:** A visual display of the keys you've collected.

MAP

To toggle the Status display to the map press the circle button. Use the map to find your way around F.U.B's den of inequity. Areas you haven't already visited will be slightly darker than those you have.

KEYS

To open the doors you'll need to find the keys. You'll notice that each door is color-coded, so you'll need to collect the correct colored key to open the door.

PICK UP THE POWER-UPS

WEAPON POWER-UP

This powers your weapon up to full blast. Make them feel your hatred. Pick up as many of these as is possible to set your weapon to instant death.

AMMUNITION

Each grate contains much needed ammunition. Pick these up to keep your weapon fully locked and loaded. If you run out of ammunition your weapon will automatically switch to low power making it less effective against the enemy.

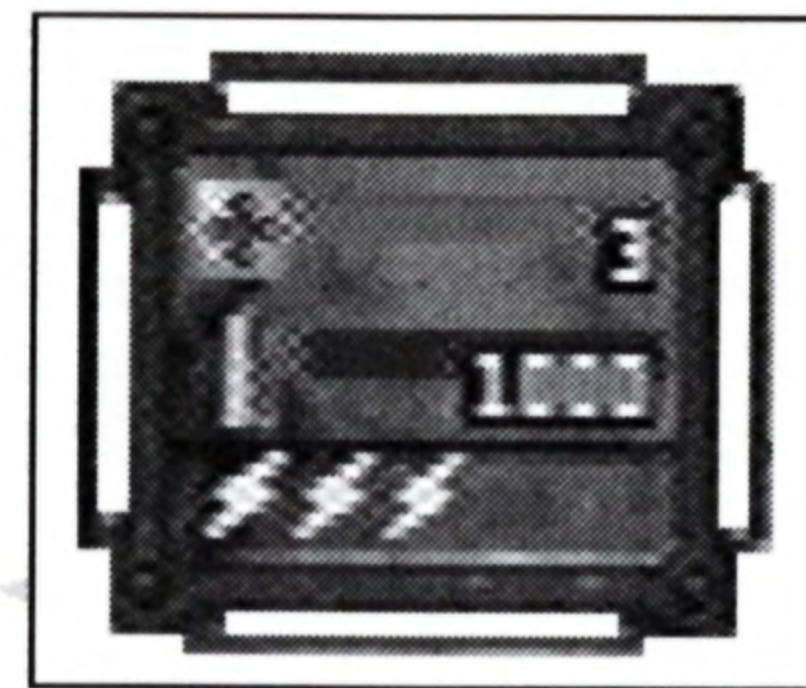

HEALTH

One of these will re-power your health to full.

SMART BOMBS

The ultimate in weaponry; let one of these babies go and it's blood baths all 'round.

EXTRA LIVES

Pick these up to give yourself an extra life.

OTHER POWER-UPS

There are a few other power-ups available in LOADED but we don't want to spoil it for you, so here's pictures of them. You'll have to work out what they do yourself!

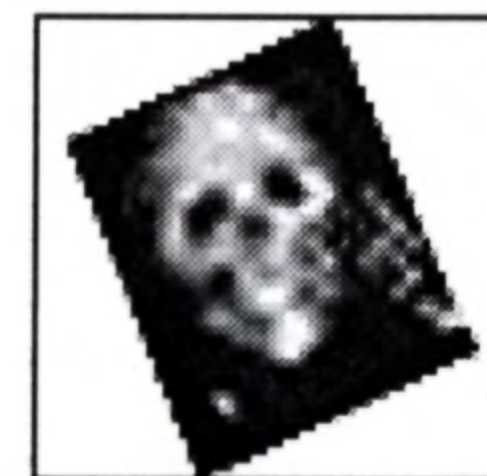

RESULTS SCREEN



After you've successfully completed a level you'll be presented with a Results screen; this is a bit like a school report—well, it's like mine! You get points and percentages for your performance plus a prediction on your future career prospects. Here's a break down of the report screen:

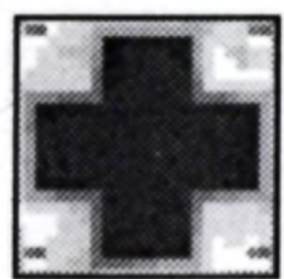

GREED-FACTOR

What do you mean, you didn't pick up the credit tokens after wiping out all the guards, etc.? Collect up you schmuck and increase your greed factor.



ACCURACY

How accurate you are with your weapon.



BODY COUNT

Total number of bodies taken out with your mighty weapon.



CAREER PROSPECTS

Your skill in all the above categories are taken into account and from these we predict your future career prospects. Forget the careers officer and the DSS; our advice comes from the highest intelligence -- ignore it at your own peril.



SCORE

Your total score with all percentages and scores added together.

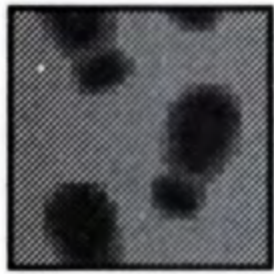

SAVE

After every level you've successfully completed you'll be allowed to save your progress using Save from the Results screen. Make sure your memory card is inserted before you select this option. Highlight Save and press the X button. Now select a slot, highlight Slot and press the X button to toggle between Slot 1 and Slot 2. Then highlight and select Save. Select an available save position and press X to save the game. Your game will now be saved to the selected slot and a small portrait of your selected character and the level number will appear in the slot making it easier to identify your saves. Another option on the save screen is Format. If you select this option, all the previous saves on any selected memory card will be erased. You can over-write previously saved games with newer saves if you wish.



CONTINUE

Highlight and press the X button to continue on to the next level.

IN-GAME MENU

At any point in the game press START to access the in-game menu. From this menu, you can change the volume of the in-game music and sound effects. Use up and down on the D-pad to select an option and left to decrease the volume and right to increase the volume. Once you've adjusted your options select Resume to continue the game or Quit to leave the current game and return to the main menu screen.

WALK-THROUGH

Need your hand held, huh? Well, though we'd much rather just throw you into the deep end and watch you flounder around, we'll give you a break and take this nice and slow. But don't expect any more favors. You know the drill: put the CD into the PlayStation, close the top, press Power to start it up, wait through some intro screens, yadda yadda yadda. Okay. Your first option is Language — seeing as you're reading this manual in English you're probably going to want the game in English too, but hey, it's your choice. If you can't figure out how to select an option on this or the main menu screen (which is coming up in a minute, hold your horses), then go back and read page 7 again, for cryin' out loud!



On the main menu screen, we suggest that if you want to keep up, you should scroll down to Options and make life as easy on yourself as possible: toggle to Players Are Fairies, max out your lives and continues, etc. You can get as macho as you want later, on your own time. Now, get back out to the main menu and choose 1P Game. This will bring up another option screen: which psychotic nutball do YOU feel like playing today? Use the D-pad to check out your options around the sides of the screen. You can play whoever you want, but WE'RE gonna go with Vox this time around. She's the blonde babe with the killer sonic attack, in the upper right corner of the screen. (Uh, hey, don't tell her we called her a "babe," okay?) All right, enough of that, on with the game. This is fairly simple and straight forward: if it moves, blast it until it DOESN'T move. This goes for guards, inmates, other mercs, cannons, tanks...heck, even crates, bunks, and boxes if you like. You begin in the middle of the prison, and all of the doors are locked up tight; to find a way out, you've got to scour each room for keycards to other sections. Walk down towards the bottom of the screen (using the D-pad), turn right, and follow that corridor. It's a little shadowy, but you should be able to spot the yellow keycard that some careless guard dropped in the middle of the hallway. Walk through the card to grab it and then head back to where you started, on the big black-and-yellow P.

Cool. Now, head up towards the top of the screen. Right before you head up that corridor, there's a door to your right. That door should now open — be careful! That guard is more than ready to leap out and beat the living daylights outta you...and he's got a partner lurking in the shadows! You should be able to figure out what to do about them. Hint: it involves aiming your gun, pressing X, and admiring the artistic merits of the ensuing splatter.

Once you've cleaned out that room (thought perhaps "cleaned" is the wrong word to use) and grabbed your prize (that box with the skull on it in the upper part of the screen), get out and continue up the corridor above you. Brace yourself: there's a war zone through that door at the end! In a real jam, press <triangle> to cut loose with a devastating ultra-bomb and hammer everything in sight. If you get killed, don't worry about it too much — you should have some lives and continues left. And if you're quick, you can snatch up your power-ups (the skull-boxes) and resume firing. Between skirmishes, keep an eye on your map in the upper left corner of the screen to make sure that you're checking out every single room; you never know where that next power-up or keycard might be hidden.

Kill everyone, destroy everything, search everywhere. What more need we say? It's dark, it's dangerous, and you have a loooooong way to go...

The word "LOADED" is written in a large, black, splatter-style font. Each letter is thick and irregular, with many small black dots and splatters radiating from the edges, giving it a messy, blood-splattered appearance. The letters are arranged horizontally across the center of the page.

CREDITS

US Executive Producer

Alan Pavlish

US Division Director Action/Arcade

Mark Nausha

US Producer

Jeremy Airey

UK Producer

Mark Glossop

US Line Producer

Brian McInerney

Programming

Ashley Bennet

Paul Hiley

Andrew Chapman

Jim Tebbutt

Matthew Hopwood

Philip Rankin

Graphics

Michael Hirst

Wai Ming Yen

Pre-Rendered 3D Graphics

Matt Furniss

Original Concept

Ade Carless

Alex Syrichas

Character Artwork

Greg Staples

Music & Sound Effects

Neil Biggin

Patrick Phelan

Additional Music

Pop Will Eat Itself

Map Editor

Steve Lovesey

Level Editing

Simon Short

US Quality Assurance Director

Jeremy S. Barnes

US Quality Assurance Leads

Larry Smith

Bill Delk

US Quality Assurance Team

Jeff Woods

Alan Barasch

Marvic Ambata

Aaron Olai

David Hendee

Hyle Shubel

Chris Keenan

Phuong Nguyen

Steve Theskan

Quinn Summers

Glenn Murray

Savina "CPT. Krik" Greene

Michael Motoda

Manual Layout & Design

Jennifer Hillis

Manual Editors

Michael Motoda

Bruce Warner

Manual Cover & Package Design

Dave "dj" Gaines



Customer Support

If you have any questions about this, or any other Interplay product, you can reach our Customer Service/Technical Support Group at:

Interplay, 16815 Von Karman Avenue, Irvine, CA 92606 Attn: Customer Service. Customer Service is available 24 hours a day through our Automated Customer Service system, with a Customer Service representative available during normal business hours at (714) 553-6678.

Please have your system information available, or better yet, try to be at your Playstation. The more detailed information you can provide our support personnel, the better service we can provide you.

If you have a modem, you can reach us at the following:

The Interplay BBS: We have a 24-hour, 7-day a week multiline BBS available for customer questions, support and fixes. The number is 714-252-2822. Modem settings are 300-28.8k Baud, V.32bis, V.42bis, 8-N-1. You also may contact our BBS over the Internet.

Telnet to bbs.interplay.com. This is a free service.

America Online: You can E-mail Interplay Customer Support at IPTECH. To reach our Customer Support board in the Industry Connection, press CTRL-K for "Go To Keyword." Then type INTERPLAY in the Keyword window. In addition to reading and leaving messages, you can download fixes and demos from the "Software Libraries."

CompuServe: We are available for IBM and compatible on-line support. We are located in the Game Publishers B Forum, type GO GAMBUP at any "!" prompt. Then select "Section 4" for Interplay Productions. You can leave technical support questions there. You can also download fixes and demos from Library 4 in GAMBUP. The best place for game play hints about our games is in the GAMERS forum. If you are not already a CompuServe member, you can call CompuServe toll-free at 1-800-524-3388 and ask Representative #354 for a free introductory membership and a \$15 usage credit. For game play hints look in the Gamer's Forum (GO GAMERS). Besides technical support for Interplay products, CompuServe offers many other services, including communications, reference libraries, hardware and software support, travel, games and much more.

PRODIGY® Interactive Personal Service: You may send mail directly to us. Our ID is "PLAY99B".

Internet: You can reach Interplay by sending Internet E-mail to "support@interplay.com". Many Interplay demos and patches are available at Internet FTP sites. To visit our World Wide Web site, point your browser to: "<http://www.interplay.com>" or you may ftp to [ftp.interplay.com](ftp://ftp.interplay.com).

Limited Warranty

INTERPLAY LIMITED 90-DAY WARRANTY

Interplay warrants to the original purchaser of this Sony PlayStation™ product that the compact disc on which the software programs are recorded will be free from defects in material and workmanship for 90 days from the date of purchase. If the compact disc is found defective within 90 days of original purchase, Interplay agrees to replace, free of charge, any product discovered to be defective within such period upon receipt at its factory service center of the product, postage paid, with proof of the date of purchase. This warranty is limited to the compact disc containing the software program originally provided by Interplay and is not applicable to normal wear and tear. This shall be void if the defect has arisen through abuse, mistreatment, or neglect. Any implied warranties applicable to this product, including warranties of merchantability and fitness for a particular purpose are disclaimed. Interplay disclaims all responsibility for incidental or consequential damages.

Some states do not allow limitations as to how long an implied warranty lasts and/or exclusions or limitations of incidental or consequential damages so the above limitations and/or exclusions or liability may not apply to you. This warranty gives you specific rights, and you may also have other rights which vary from state to state.

Lifetime Warranty

If the compact disc should fail after the original 90-day warranty period has expired, you may return the software program to Interplay at the address noted below with a check or money order for \$15.00 (U.S. currency), which includes postage and handling, and Interplay will mail a replacement to you. To receive a replacement, you need to enclose the original defective compact disc in protective packaging accompanied by: (1) a \$15.00 check or money order, (2) a brief statement describing the defect, and (3) your return address. If you have a problem with your software, you may wish to call us first at (714) 553-6678. If your compact disc is defective and a replacement is necessary, U.P.S. or registered mail is recommended for returns. Please send the defective disc(s) only (not the box) with a description of the problem and \$15.00 to:

Warranty Replacements
Interplay Productions
16815 Von Karman Avenue
Irvine, California 92626

Copying Prohibited

This software product and the manual are copyrighted and all rights are reserved by Interplay Productions and are protected by the copyright laws that pertain to computer software. You may not copy the software except that you may make one copy of the software solely for backup or archival purposes. You may not loan, sell, rent, lease, give, sub license, or otherwise transfer the software (or any copy). You may not modify, adapt, translate, create derivative works, decompile, disassemble, or otherwise reverse engineer or derive source code from, all or any portion of the software or anything incorporated therein or permit or encourage any third party to do so.

NOTICE: Interplay reserves the right to make modifications or improvements to the product described in this manual at any time and without notice.

Interplay Productions • 16815 Von Karman Avenue • Irvine, CA 92606 • (714) 553-6678

©1997 Gremlin Interactive Limited. MCPS. All rights reserved. Loaded is a trademark of Interplay Productions. All rights reserved. Interplay is the sole publisher and distributor. Licensed from and developed by Gremlin Interactive Ltd. Sony® is a registered trademark of Sony Corporation. PlayStation™ and the PlayStation Logo are trademarks of Sony Computer Entertainment Inc.



Licensed by Sony Computer Entertainment America for use with the PlayStation game console. PlayStation and the PlayStation logos are trademarks of Sony Computer Entertainment Inc. The ratings icon is a trademark of the Interactive Digital Software Association.

Manufactured and printed in the U.S.A. THIS SOFTWARE IS COMPATIBLE WITH PLAYSTATION GAME CONSOLES WITH THE NTSC U/C DESIGNATION. U.S. AND FOREIGN PATENTS PENDING.

